



**EVERWIN VIDHYASHRAM**

18.02.2020

TRY AT HOME

LKG

*Math : (Refer Practise Note).*

*PA 4 (19.02.2020)*

*Math : Oral 1 to 100, concepts Pg.No.73 to 77 (Refer Term 3 Book).*

Circle the far object

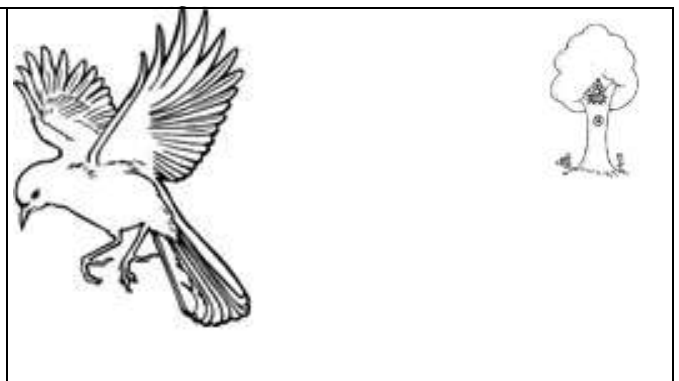
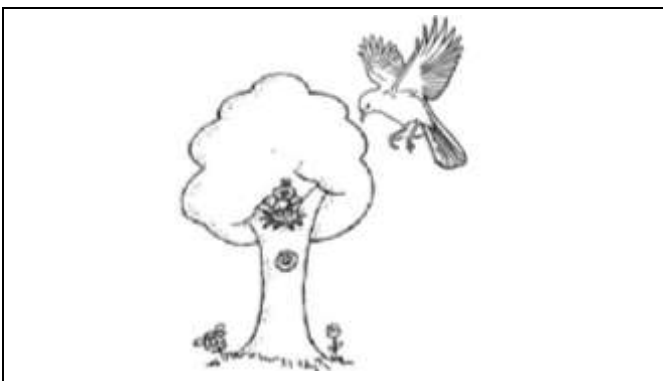
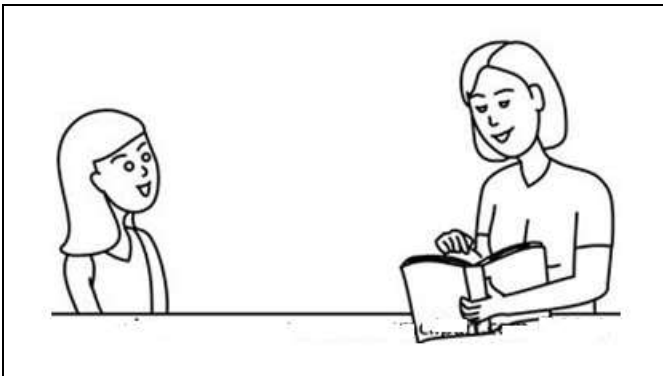

Circle the near objects

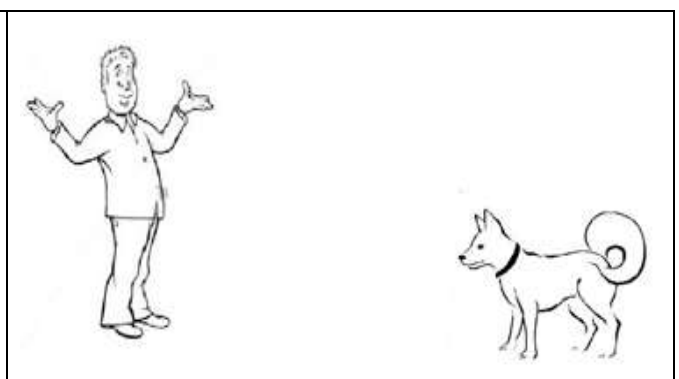
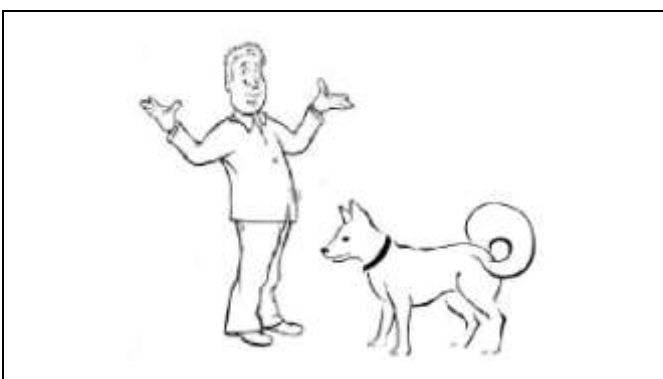
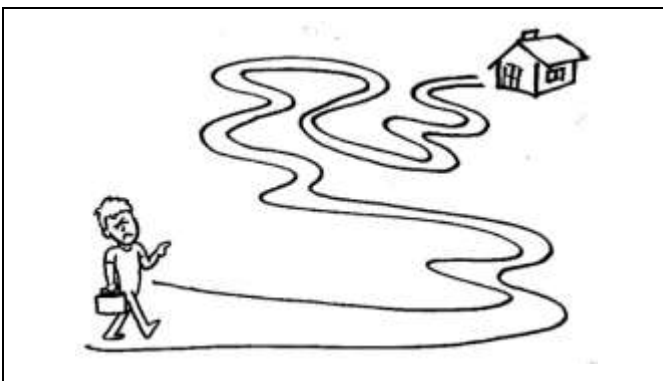

Circle the heavy object

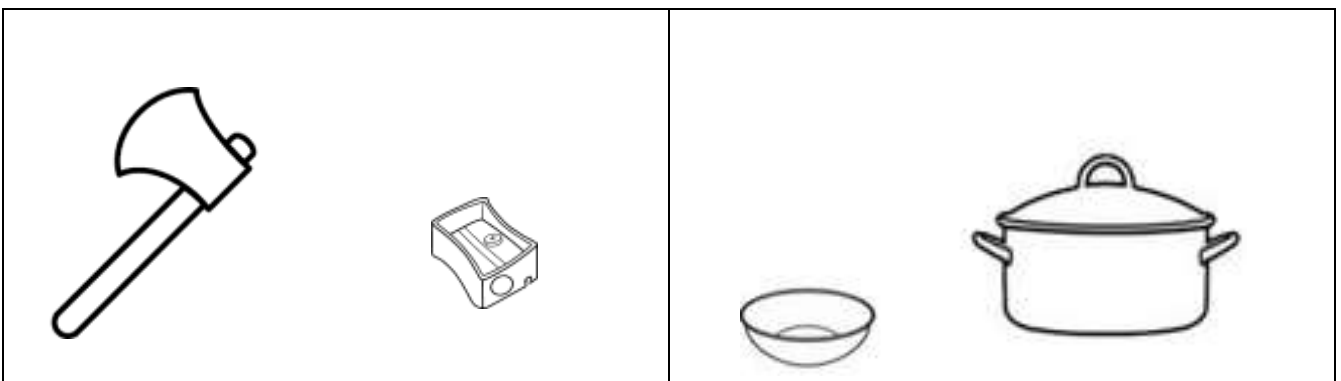
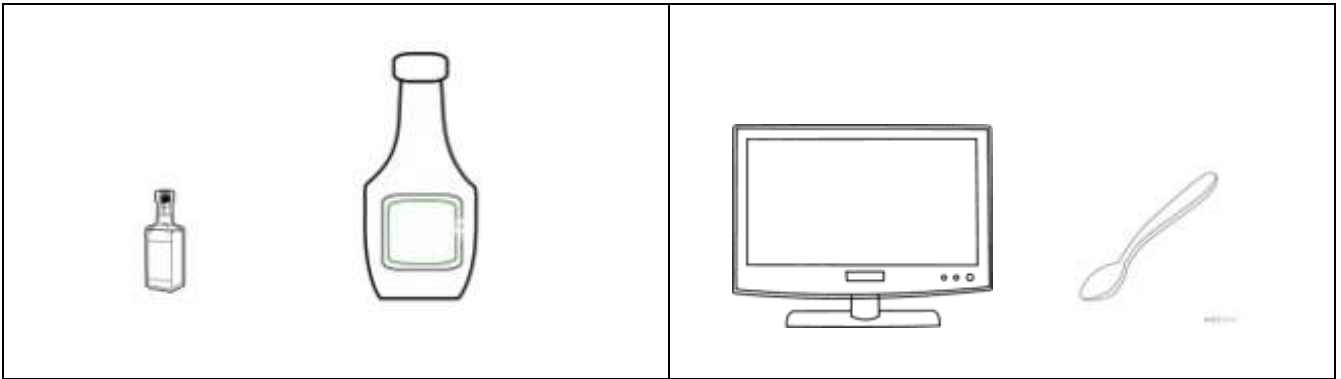

Circle the light object

